

PNL101

cod.

Pannello in bilaminato e struttura in alluminio 100x250

nome

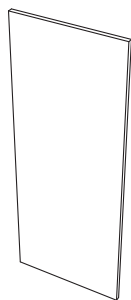

Simbolo su allegati



Descrizione prestazioni

Pannello in bilaminato con struttura modulare in alluminio tipo Octa-norm o similare.

Altezza 250cm.  
larghezza 100cm.

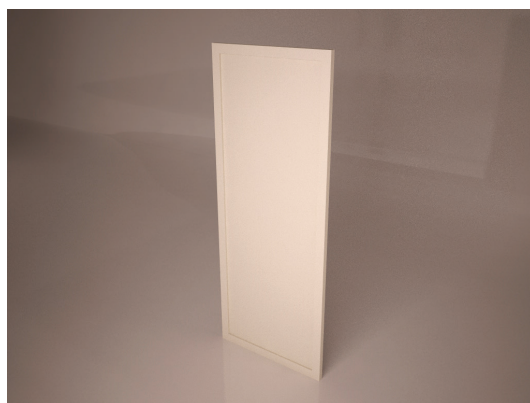
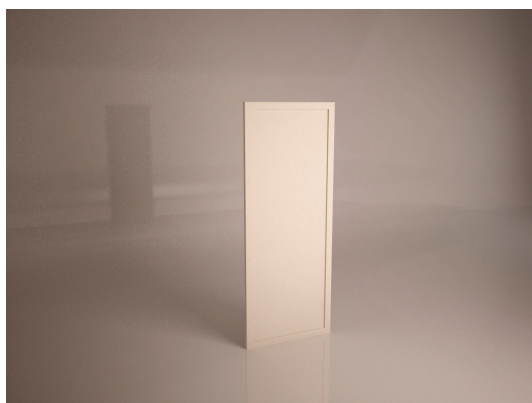
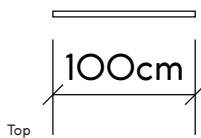
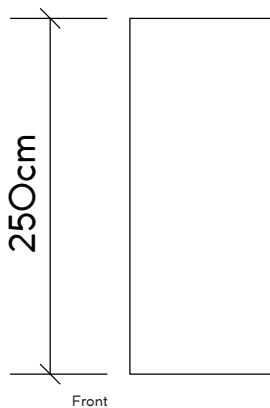

PNL102

cod.

Pannello in bilaminato e struttura in alluminio 50x250

nome



Simbolo su allegati



requisiti prestazionali

Pannello in bilaminato con struttura modulare in alluminio tipo Octa-norm o similare.

Altezza 250cm.  
larghezza 50cm.

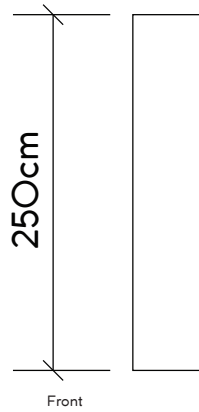

Front



Top

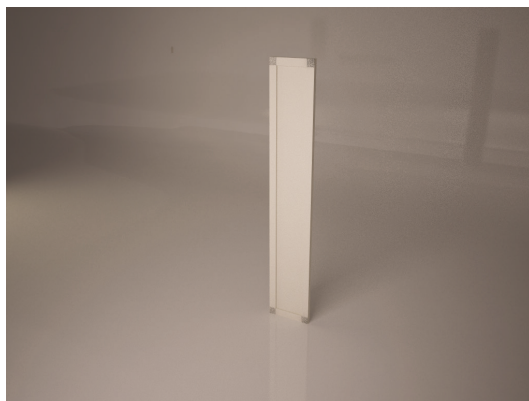

PNL103

cod.

Porta per struttura in alluminio

nome

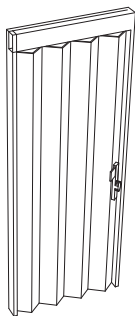

Simbolo su allegati



requisiti prestazionali

Pannello porta in bilaminato con struttura in alluminio tipo octa-norm o similare

Altezza 250cm.  
larghezza 100cm.

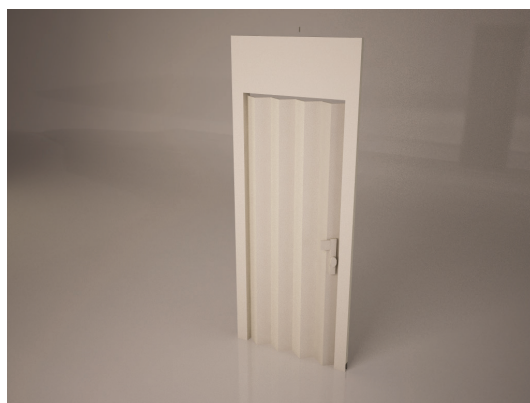
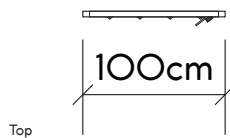
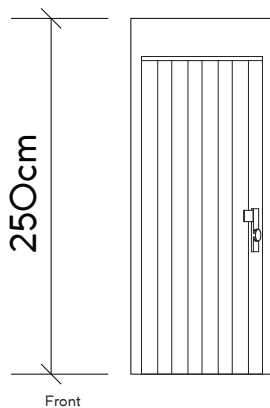

PNL104

cod.

Frontalino di collegamento per struttura in alluminio

nome



Simbolo su allegati



requisiti prestazionali

Frontalino di collegamento in pannelli bilaminati per riferimento PNL101, PNL102, PNL103, nel medesimo materiale.

Altezza da 0.05 a 0.30cm.  
lunghezza variabile in base alle piante allegate.

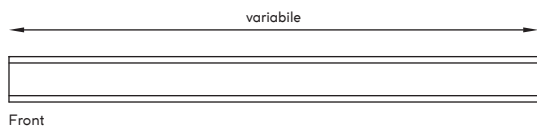

Front

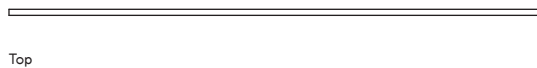

Top

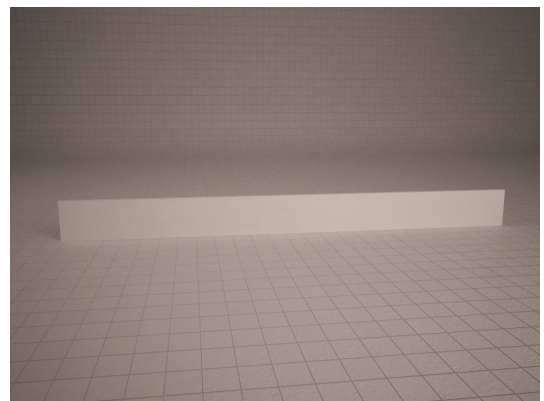
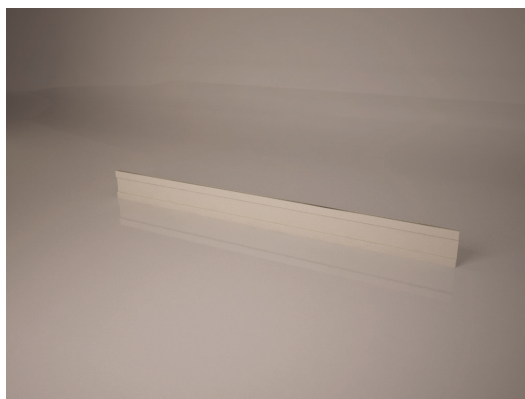



PNL105

cod.

Pannello senza montanti in legno tamburato 100x250x4

nome

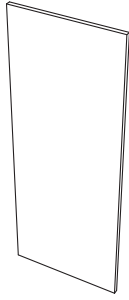

Simbolo su allegati

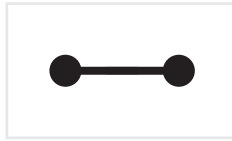

requisiti prestazionali

Pannello senza montanti in legno tamburato 100x250x4cm.

Colore bianco.

Altezza 250cm.  
larghezza 100cm.  
spessore 4cm.

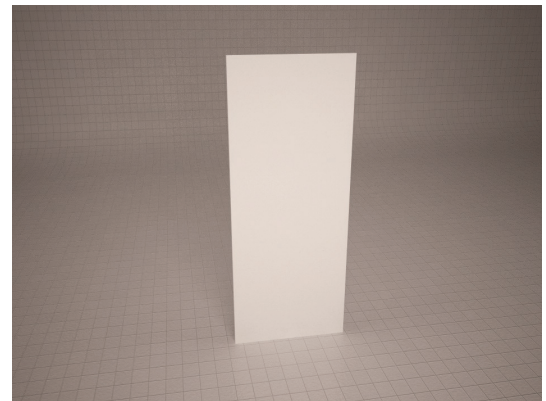
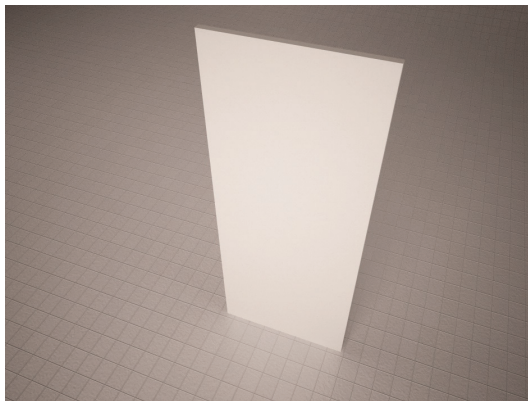
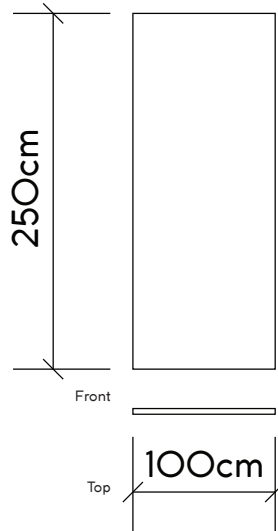

PNL106

cod.

Pannello senza montanti in legno tamburato 50x250x4

nome



Simbolo su allegati

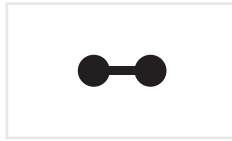

requisiti prestazionali

Pannello senza montanti in legno tamburato 50x250x4cm.

Colore: bianco.

Altezza 250cm.  
larghezza 50cm.  
spessore 4cm.

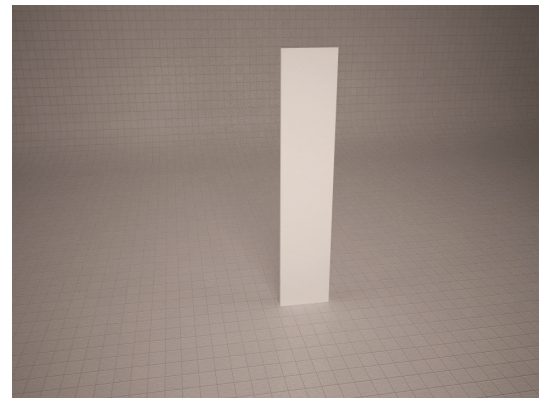
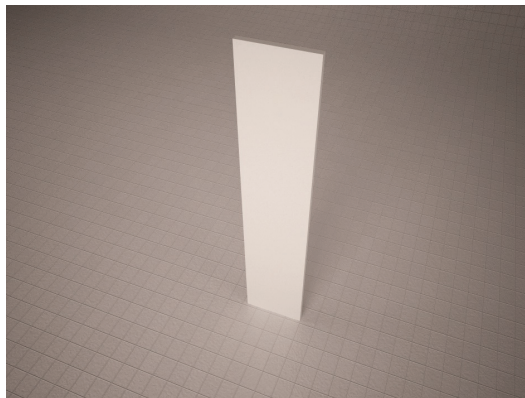
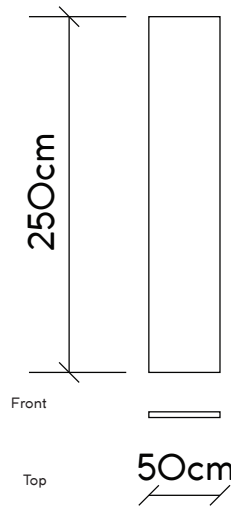

PNL107

cod.

Pannello-porta, in legno tamburato

nome

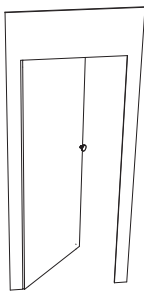

Simbolo su allegati

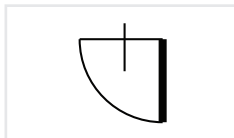

requisiti prestazionali

Pannello senza montanti in legno tamburato 100x250x4cm.

Colorazioni possibili: bianco, nero, arancione, blu, azzurro, grigio, giallo, rosso.

Altezza 250cm.  
larghezza 100cm.  
spessore 4cm.

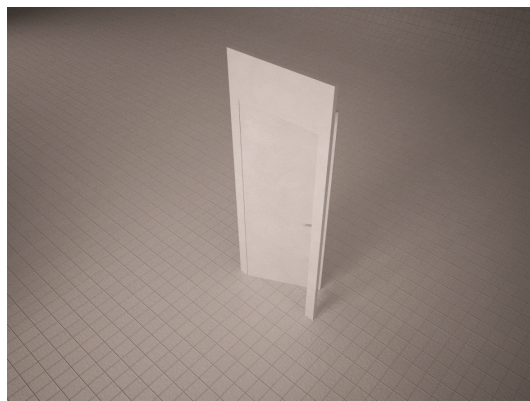
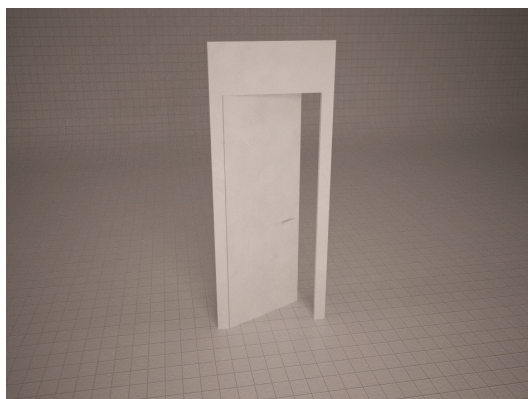
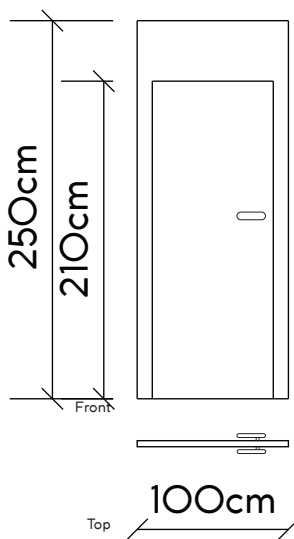

PNL108

cod.

Frontalino di collegamento in legno tamburato

nome

Simbolo su allegati

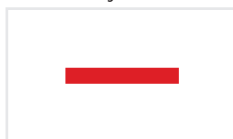

requisiti prestazionali

Frontalino di collegamento in legno tamburato per i riferimenti PNL105,106,107 nel medesimo materiale.

Altezza da 0.20 a 0.30cm.  
lunghezza variabile in base alle piante allegate.

spessore 4cm.

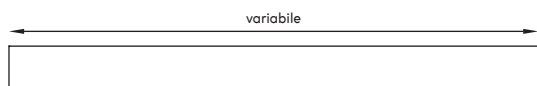

Front



Top

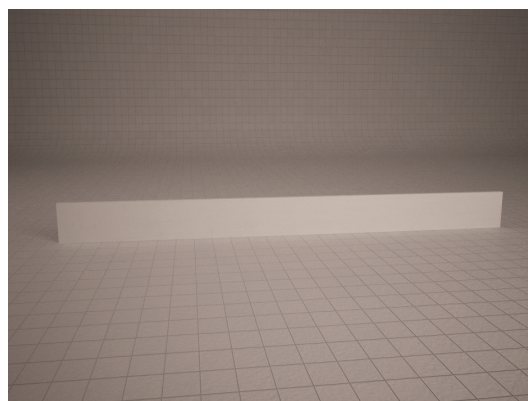
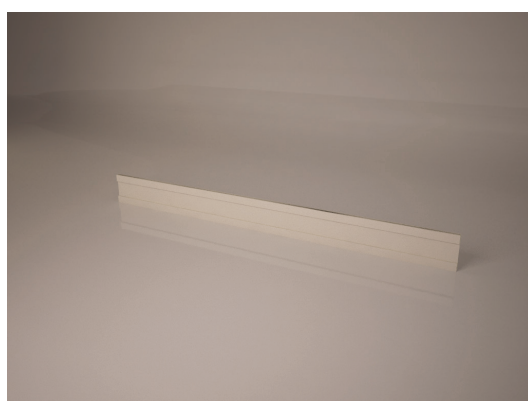

PNL109

cod.

Pannello senza montanti in legno tamburato 100x250x4 (tessuto)

nome

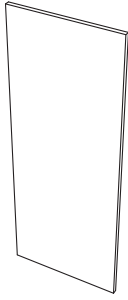

Simbolo su allegati

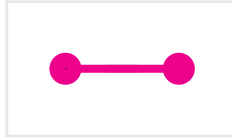

requisiti prestazionali

Pannello senza montanti in legno tamburato 100x250x4cm  
Rivestito in tessuto colorazione su richiesta.

Altezza 250cm.  
larghezza 100cm.  
spessore 4cm.

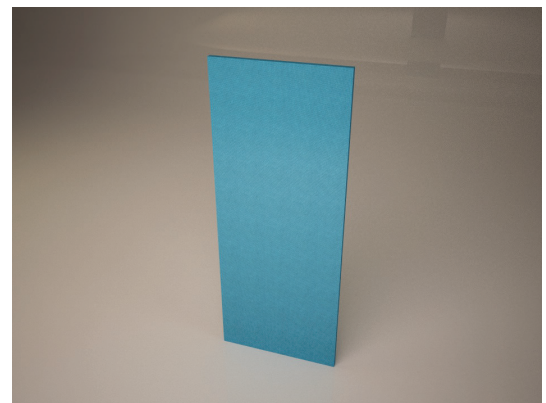
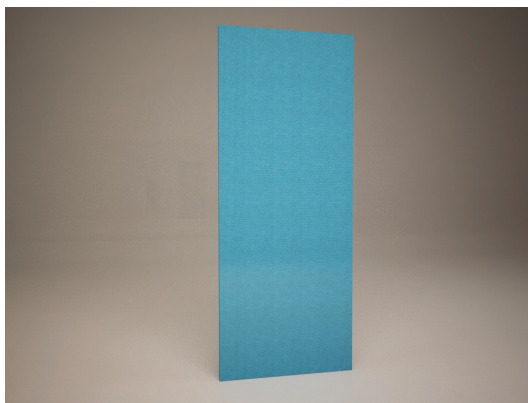
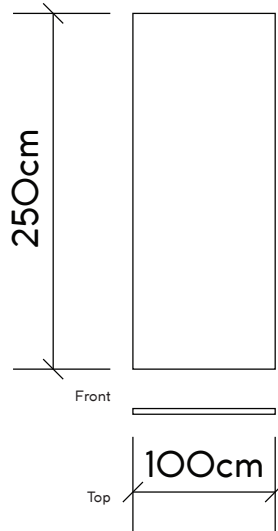

PNL110

cod.

Pannello senza montanti in legno tamburato 50x250x4 (tessuto)

nome



Simbolo su allegati

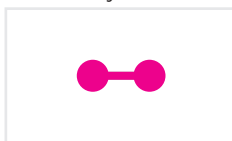

requisiti prestazionali

Pannello senza montanti in legno tamburato 50x250x4cm  
Rivestito in tessuto colorazione su richiesta.

Altezza 250cm.  
larghezza 50cm.  
spessore 4cm.

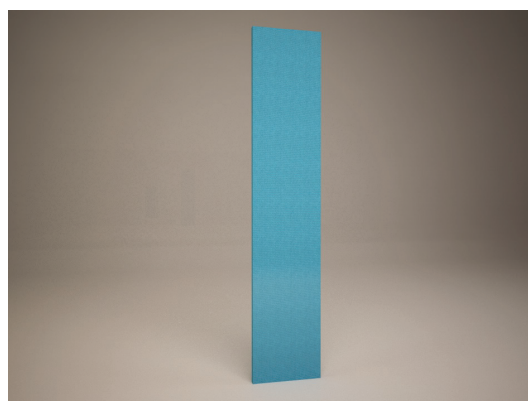
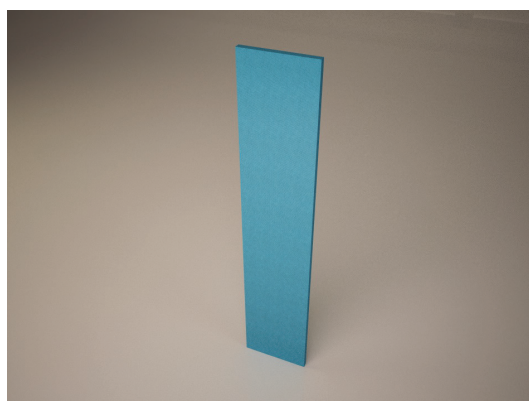
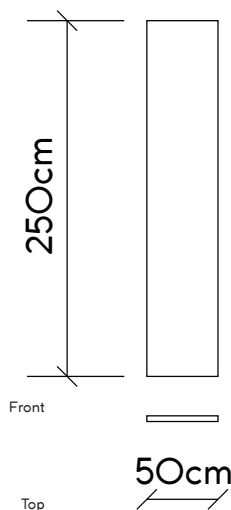

PNL111

cod.

Pannello trasparente 100x250 per struttura in LEGNO

nome

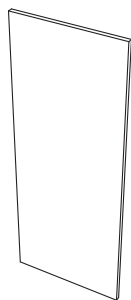

Simbolo su allegati

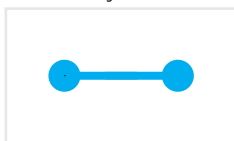

requisiti prestazionali

Pannello trasparente in materiale pma plexiglass o vetro o altro materiale analogo.

Altezza 250cm.  
larghezza 100cm.  
spessore 4cm.

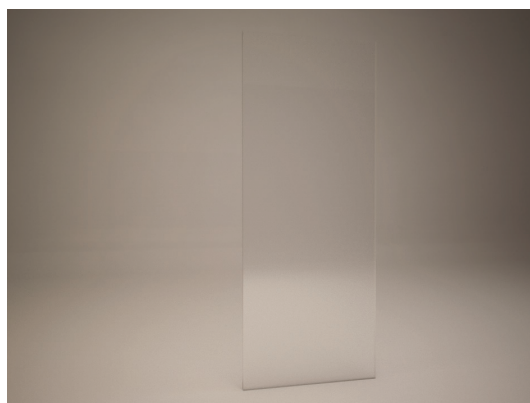
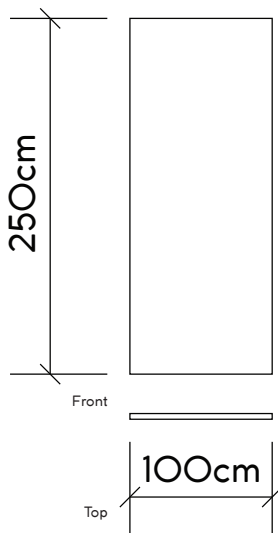



PNL112

cod.

Pannello senza montanti in legno tamburato 100x210x4

nome

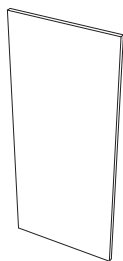

Simbolo su allegati

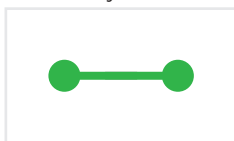

requisiti prestazionali

Pannello senza montanti in legno tamburato 100x210x4cm.

Colorazioni possibili: bianco, nero, arancione, blu, azzurro, grigio, giallo, rosso.

Altezza 210cm.  
larghezza 100cm.  
spessore 4cm.

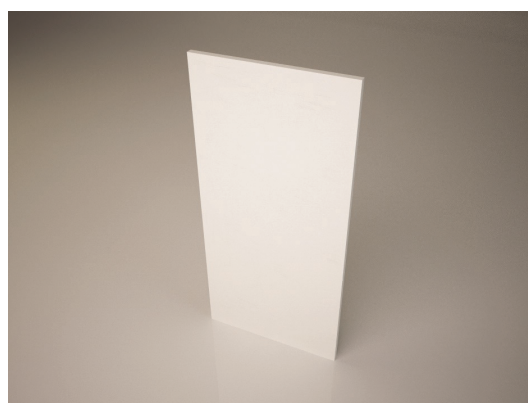
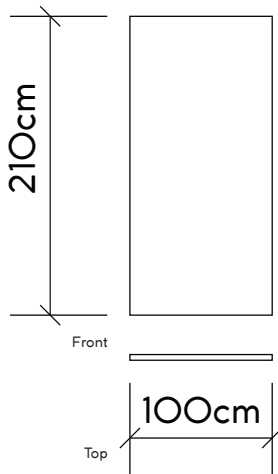



PNL113

cod.

Pannello senza montanti in legno tamburato 50x210x4

nome



Simbolo su allegati

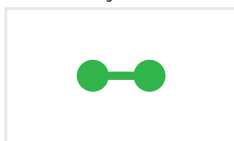

requisiti prestazionali

Pannello senza montanti in legno tamburato 100x210x4cm.

Colorazioni possibili: bianco, nero, arancione, blu, azzurro, grigio, giallo, rosso.

Altezza 210cm.  
larghezza 100cm.  
spessore 4cm.

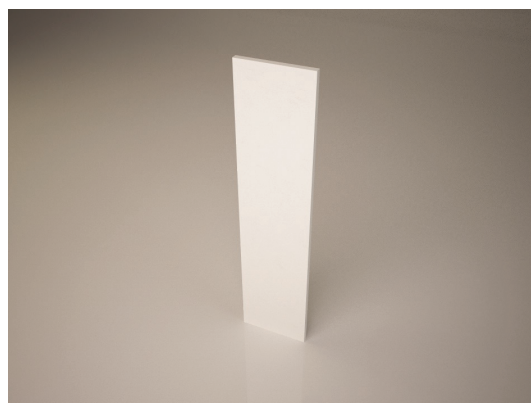
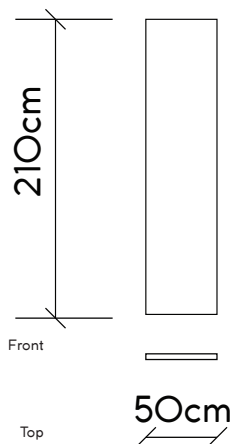

PNL114

cod.

Pannello senza montanti in legno tamburato 100x300x4

nome

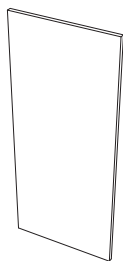

Simbolo su allegati

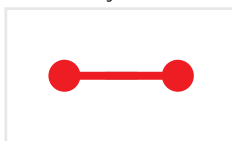

requisiti prestazionali

Pannello senza montanti in legno tamburato 100x300x4cm.

Colorazioni possibili: bianco, nero, arancione, blu, azzurro, grigio, giallo, rosso.

Altezza 300cm.  
larghezza 100cm.  
spessore 4cm.

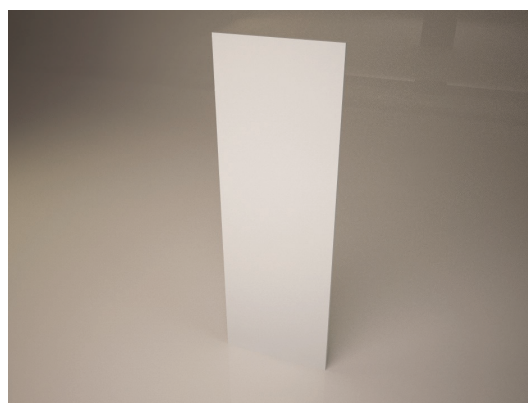
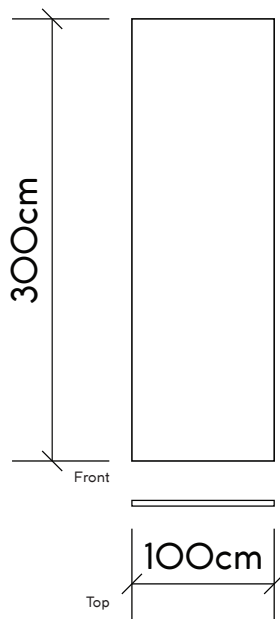

PNL115

cod.

Pannello senza montanti in legno tamburato 50x300x4

nome



Simbolo su allegati

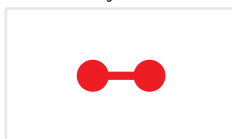

requisiti prestazionali

Pannello senza montanti in legno tamburato 100x300x4cm.

Colorazioni possibili: bianco, nero, arancione, blu, azzurro, grigio, giallo, rosso.

Altezza 300cm.  
larghezza 100cm.  
spessore 4cm.

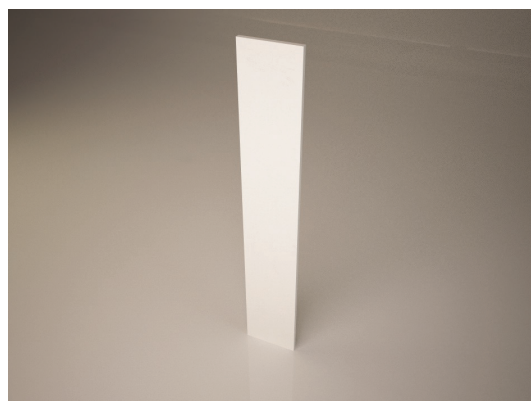
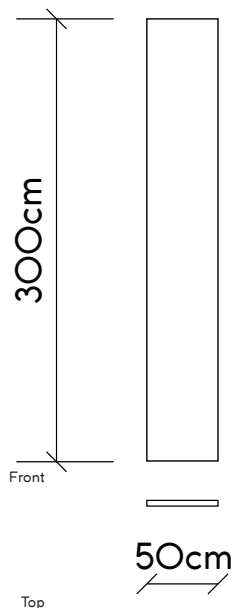

PNL116

cod.

Pannello senza montanti in legno bilaminato 100x250x4

nome

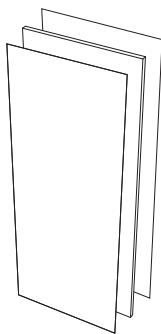

Simbolo su allegati

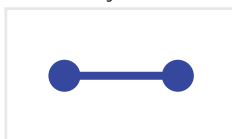

requisiti prestazionali

Pannello senza montanti in legno bilaminato 100x250x4cm.

Colori richiesti bianco o grigio.

Altezza 250cm.  
larghezza 100cm.  
spessore 4cm.

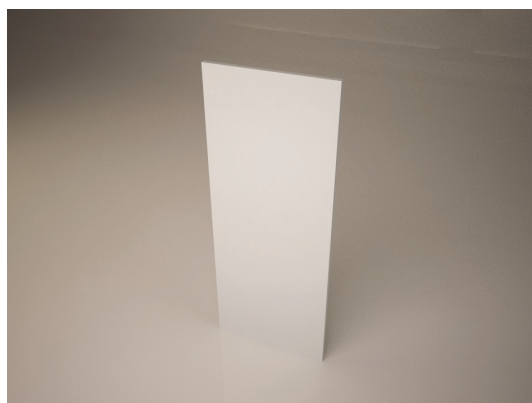
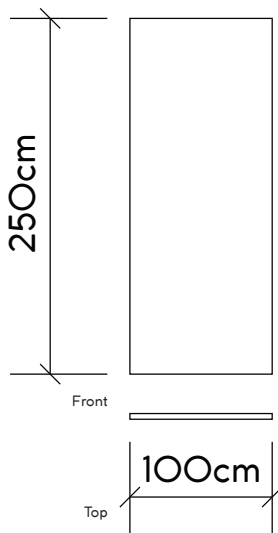

PNL117

cod.

Pannello senza montanti in legno bilaminato 50x250x4

nome

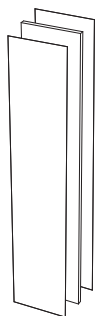

Simbolo su allegati

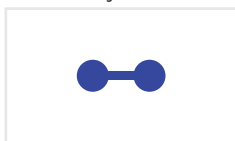

requisiti prestazionali

Pannello senza montanti in legno bilaminato 50x250x4cm.

Colori richiesti bianco o grigio.

Altezza 250cm.  
larghezza 50cm.  
spessore 4cm.

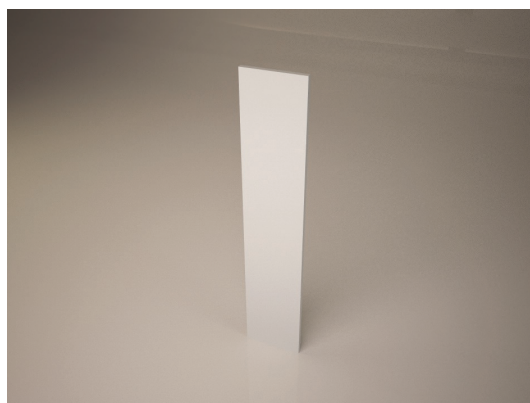
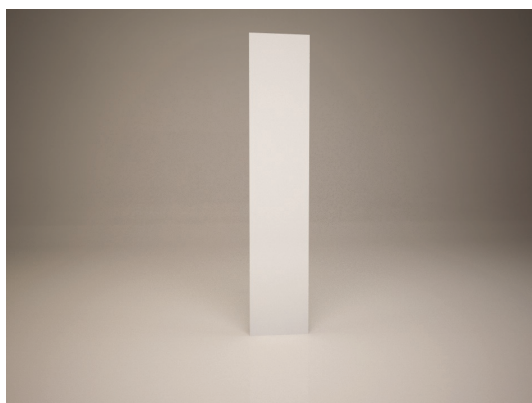
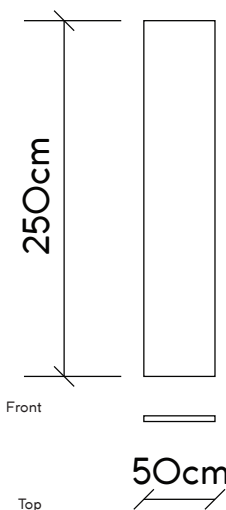

PNL118

Pannello porta in legno bilaminato 100x250

cod.

nome

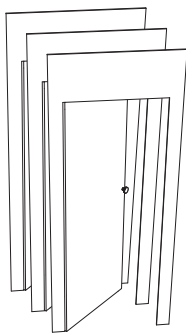

Simbolo su allegati

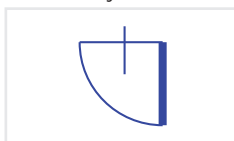

requisiti prestazionali

Pannello porta senza montanti in legno bilaminato 100x250x4cm.

Colori richiesti bianco o grigio.

Altezza 250cm.  
larghezza 100cm.  
spessore 4cm.

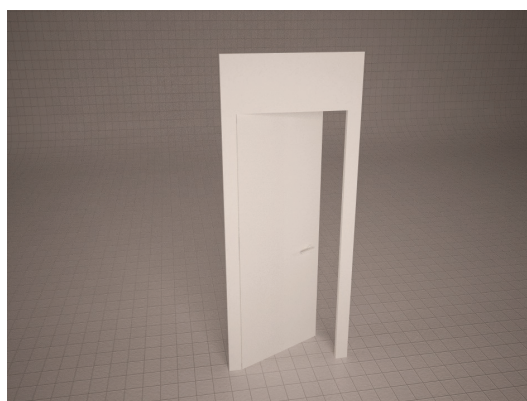
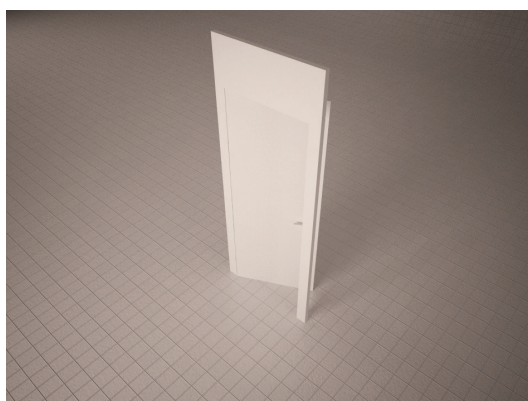
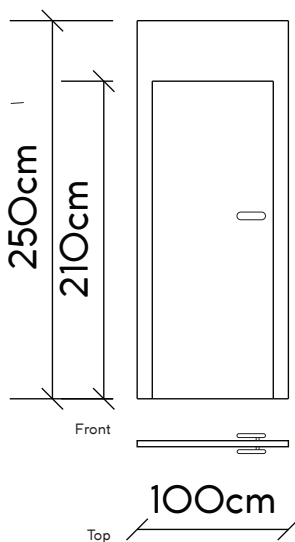

PNL119

cod.

Frontalino di collegamento in legno bilaminato

nome

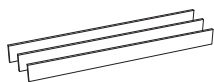

Simbolo su allegati



requisiti prestazionali

Frontalino di collegamento in legno bilaminato per i riferimenti PNL-116-117-118 nel medesimo materiale.

Altezza da 0.20 a 0.30cm.  
Lunghezza variabile in base alle piante allegate.  
spessore 4cm.

dimensione variabile

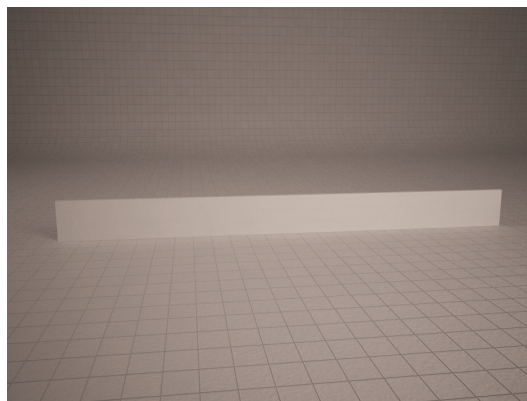
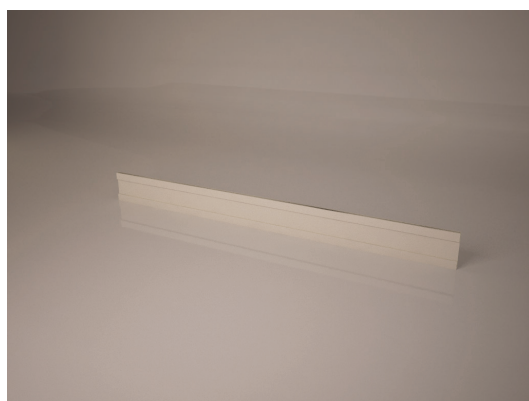
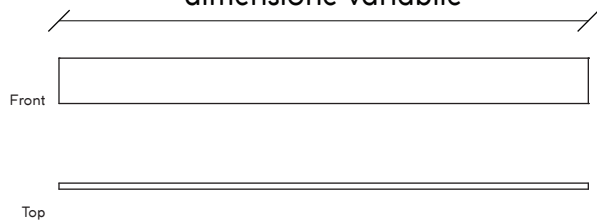

BNC151

cod.

Bancone 100x100x70

nome

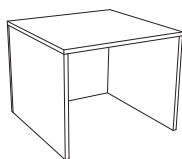

Simbolo su allegati

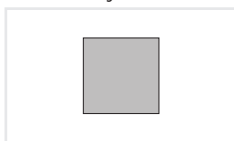

requisiti prestazionali

Bancone 100x100x70cm.  
Il bancone deve essere chiuso su tre  
lati componibile con gli altri  
elementi di arredo richiesti.

Specificare il materiale di composi-  
zione, la sua tenuta di carico e la  
colorazione.

Altezza 70cm  
Larghezza 100cm.  
Profondità 100cm.

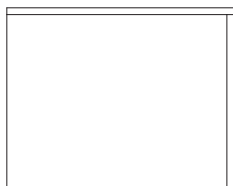

Left

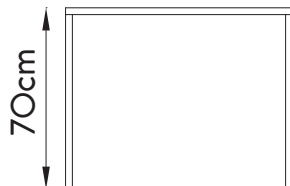

Front

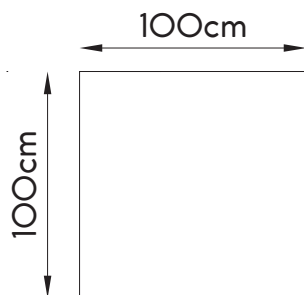

Top

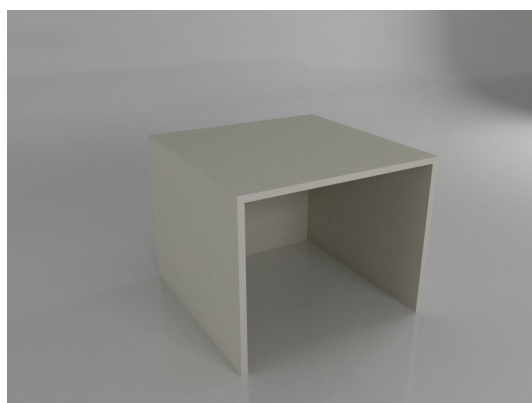



BNC152

cod.

Bancone 100x150x70

nome

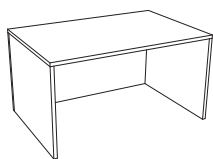

Simbolo su allegati



requisiti prestazionali

Bancone 100x150x70cm.  
Il bancone deve essere chiuso su tre  
lati componibile con gli altri  
elementi di arredo richiesti.

Specificare il materiale di composi-  
zione, la sua tenuta di carico e la  
colorazione.

Altezza 70cm  
Larghezza 150cm.  
Profondità 100cm.

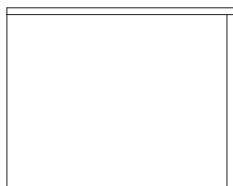

Left

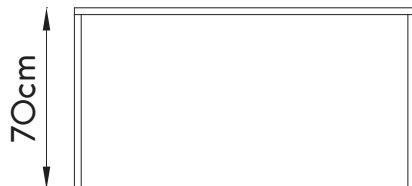

Front

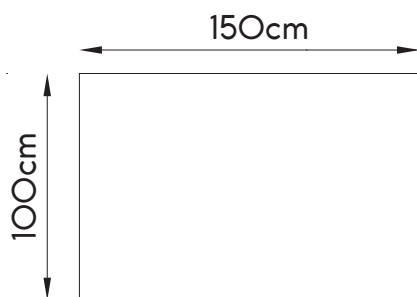

Top



BNC153

cod.

Bancone 100x200x70

nome

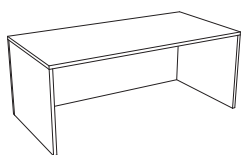

Simbolo su allegati

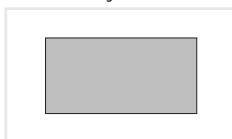

requisiti prestazionali

Bancone 100x200x70cm.  
Il bancone deve essere chiuso su tre  
lati componibile con gli altri  
elementi di arredo richiesti.

Specificare il materiale di composi-  
zione, la sua tenuta di carico e la  
colorazione.

Altezza 70cm  
Larghezza 200cm.  
Profondità 100cm.

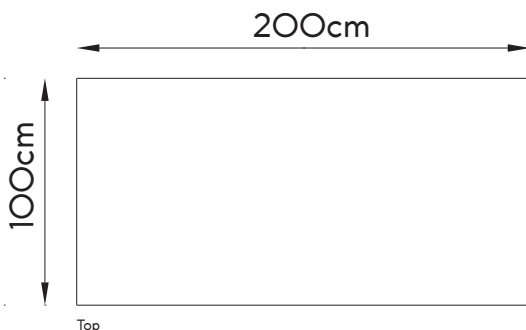
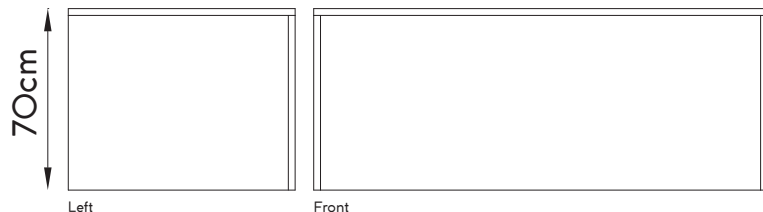

RCP201

cod.

Banco reception (singolo)

nome

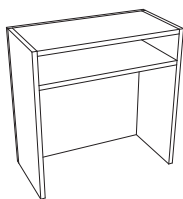

Simbolo su allegati

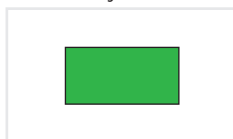

requisiti prestazionali

Banco reception con almeno un ripiano divisorio.

Non modulabile ma da utilizzare singolo.

Altezza 100cm  
Larghezza 100cm.  
Profondità 50/60cm.

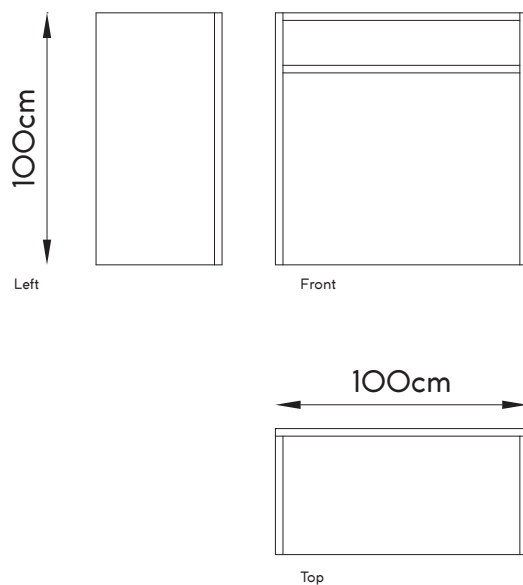

RCP202

cod.

Banco reception curvo (singolo)

nome

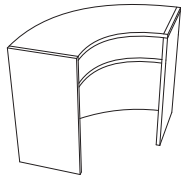

Simbolo su allegati



requisiti prestazionali

Banco reception curvo con almeno un ripiano divisorio.

Modulabile

Altezza 100cm  
Larghezza 100cm.

100cm

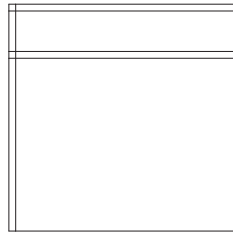

Left

100cm

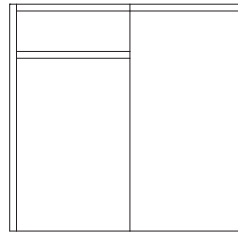

Front

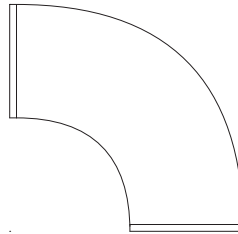

Top

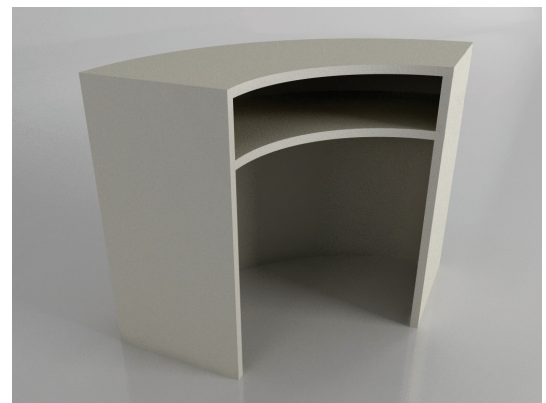
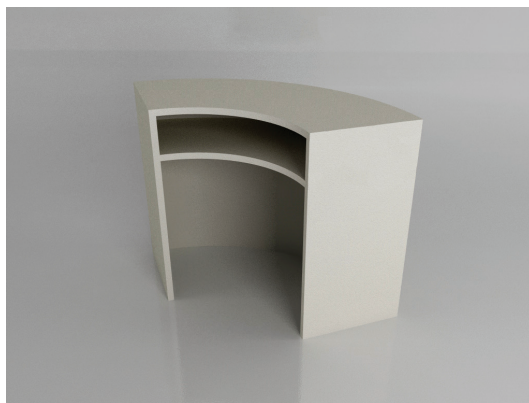

SDT301

cod.

Sedia monoscocca - struttura in metallo seduta in pvc

nome



Simbolo su allegati

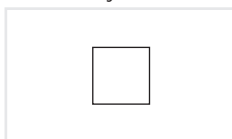

requisiti prestazionali

Sedia monoscocca in polipropilene  
struttura in metallo.

Altezza seduta 42cm



SDT3O2

cod.

Sedia con ribaltina

nome



Simbolo su allegati



requisiti prestazionali

Sedia con ribaltina.

Struttura in metallo.

Altezza seduta 40/45cm.

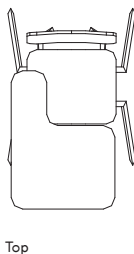
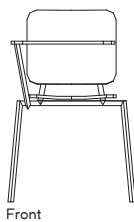
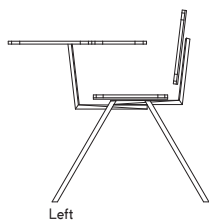

SDT3O3

cod.

Sedia per tavoli da gioco

nome



Simbolo su allegati

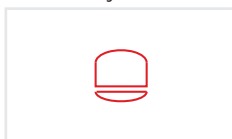

requisiti prestazionali

Sedia per tavoli da gioco in pvc  
struttura in metallo. Dimensioni  
ridotte rispetto alla norma.  
Può essere pieghevole ma con  
struttura in metallo.

Altezza seduta 40/45cm



Left



Front



Top



SDT304

cod.

Sedia imbottita

nome



Simbolo su allegati

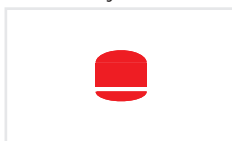

requisiti prestazionali

Sedia congresso con seduta e schienale imbottito in diverse colorazioni.

Altezza seduta 42/48 cm  
Larghezza sedile 45/55 cm  
Profondità sedile 40/45 cm





SDT305

cod.

Poltroncina relax

nome



Simbolo su allegati



requisiti prestazionali

Poltrona Relax imbottita.  
Larga seduta con schienale imbottito e seduta imbottita avvolgente.

Larghezza: 80 cm  
Profondità: 70 cm  
Altezza: 77 cm  
Larghezza sedile: 55 cm  
Profondità sedile: 55 cm



Left



Front



Top



SDT306

cod.

Sgabello alto

nome



Simbolo su allegati

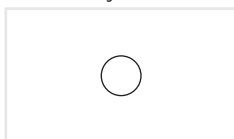

requisiti prestazionali

Sgabello alto fusto in alluminio,  
seduta in PVC

bianco, nero

Larghezza 45/50cm

Altezza 95/100cm

Profondità 45/50cm



Left

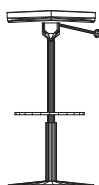

Front



Top



SDT307

cod.

Sgabello basso

nome

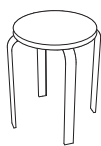

Simbolo su allegati

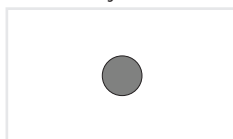

requisiti prestazionali

Sgabello basso struttura in metallo  
seduta in PVC o imbottita.

Colore richiesto Nero/grigio/bianco/rosso.

Carico almeno 120kg.

Larghezza sedile 30/35cm

Altezza 45cm

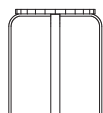

Left

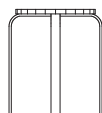

Front

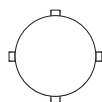

Top



TVL351

cod.

Tavolo 80x80

nome



Simbolo su allegati

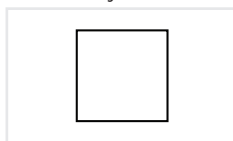

requisiti prestazionali

Tavolo con piano in legno o altra valida alternativa. Struttura in metallo.

Altezza 70cm  
Larghezza 80cm.  
Profondità 80cm.

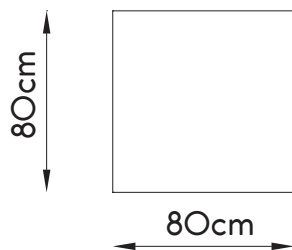
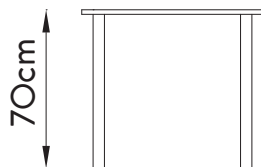

TVL352

cod.

Tavolo 80x120

nome

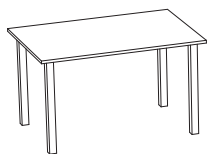

Simbolo su allegati

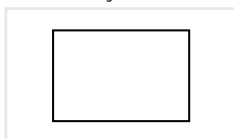

requisiti prestazionali

Tavolo con piano in legno o altra valida alternativa. Struttura in metallo.

Altezza 70cm  
Larghezza 120cm.  
Profondità 80cm

70cm



80cm



120cm



TVL353

cod.

Tavolo 80x160

nome

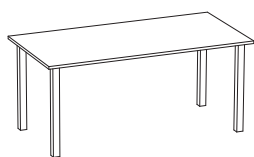

Simbolo su allegati

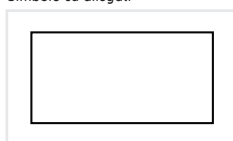

requisiti prestazionali

Tavolo con piano in legno o altra valida alternativa. Struttura in metallo.

Altezza 70cm  
Larghezza 160cm.  
Profondità 80cm

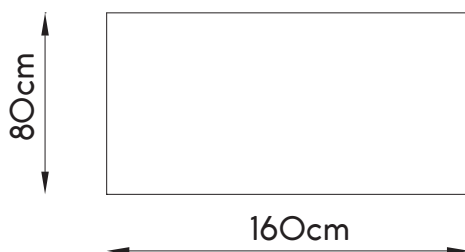

TVL354

cod.

Tavolo 80x200

nome

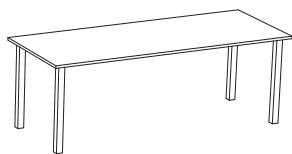

Simbolo su allegati

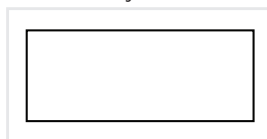

requisiti prestazionali

Tavolo con piano in legno o altra valida alternativa. Struttura in metallo.

Altezza 70cm  
Larghezza 200cm.  
Profondità 80cm



TVL355

cod.

Tavolo 100x200

nome

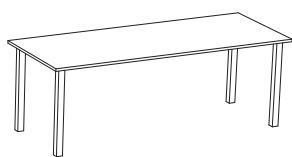

Simbolo su allegati

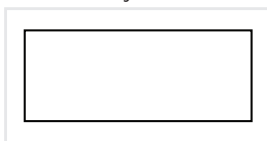

requisiti prestazionali

Tavolo con piano in legno o altra valida alternativa. Struttura in metallo.

Altezza 70cm  
Larghezza 200cm.  
Profondità 100cm

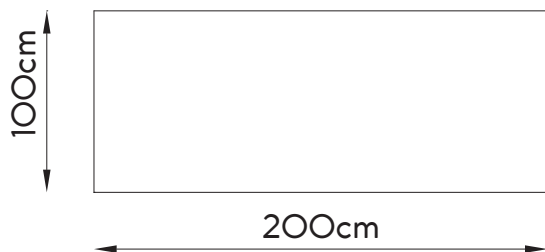



TVL356

cod.

Tavolo 120x180

nome

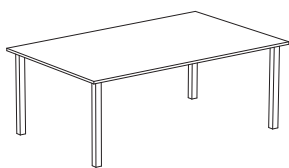

Simbolo su allegati

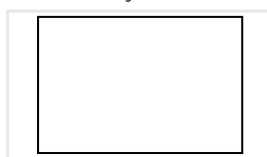

requisiti prestazionali

Tavolo con piano in legno o altra valida alternativa. Struttura in metallo.

Altezza 70cm  
Larghezza 180cm.  
Profondità 120cm

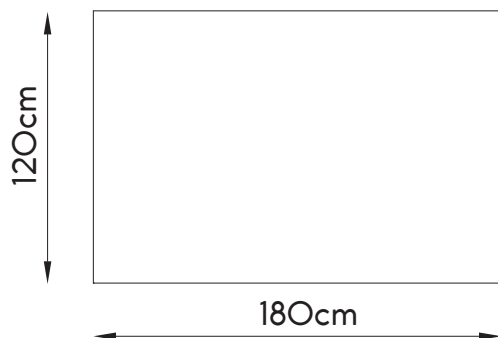

TVL357

cod.

Tavolo tondo

nome



Simbolo su allegati

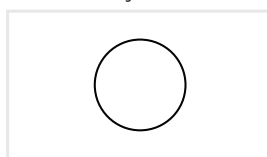

requisiti prestazionali

Tavolo rotondo con piano in legno o altra valida alternativa. Struttura in metallo.

Diametro 80cm.  
Altezza 70cm

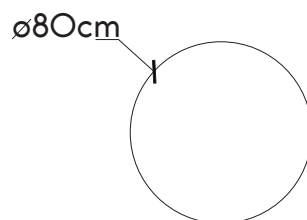
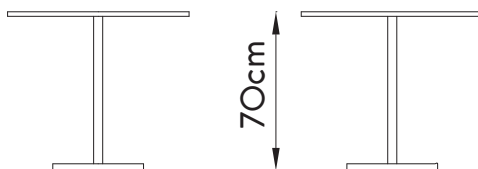

TVL358

cod.

Tavolo da fumo

nome

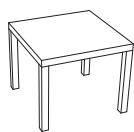

Simbolo su allegati

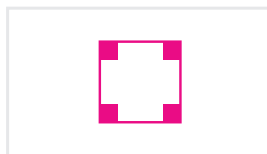

requisiti prestazionali

Tavolo da fumo

Altezza 45cm.  
Larghezza 50/60cm  
Profondità 50/60cm

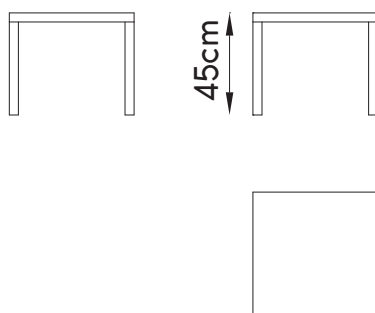

TVL359

cod.

Tavolo alto da bar

nome

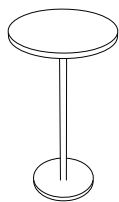

Simbolo su allegati

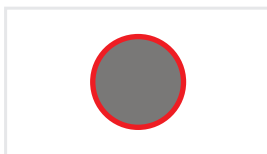

requisiti prestazionali

Tavolo alto da bar.  
Struttura in metallo.

Altezza minima 110cm  
Diametro minimo 60cm

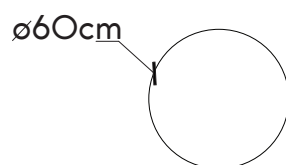
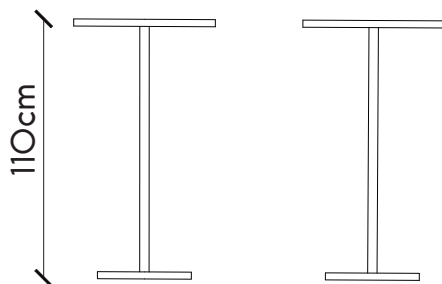

SCF451

cod.

Scaffale metallico

nome

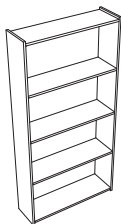

Simbolo su allegati

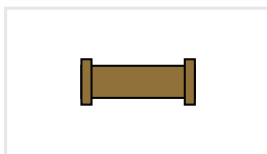

requisiti prestazionali

Scaffale metallico con almeno 3 ripiani regolabili.

Altezza 200cm.  
Larghezza 100cm.  
profondità 30cm.

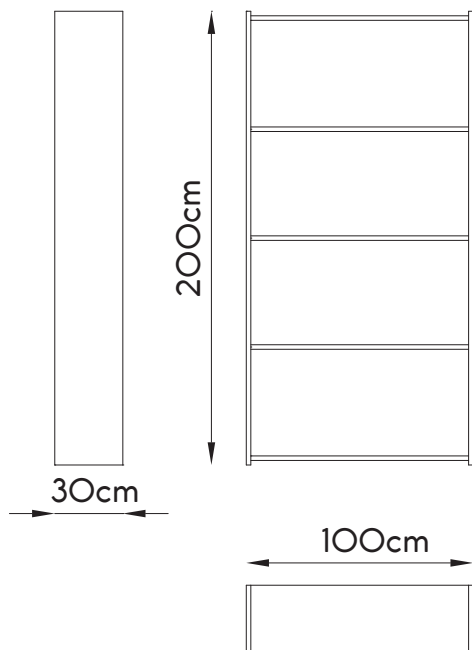

SCF452

cod.

Scaffale ripiani inclinabili

nome



Simbolo su allegati

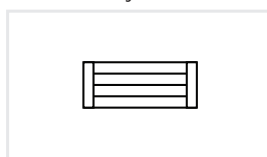

requisiti prestazionali

Scaffale in metallo o altro materiale.  
Minimo 4 ripiani regolabili anche come inclinazione.

Colore bianco/nero/metallo/legno.

Dimensioni:  
Altezza 180/250cm  
Larghezza 100cm  
Profondità 30/35cm

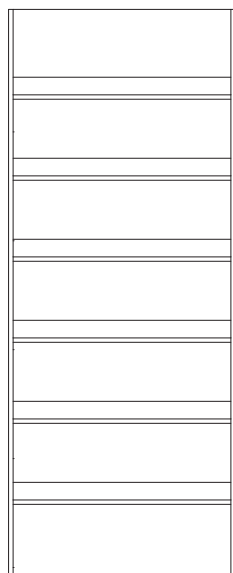

VTR501

cod.

Vetrina sez. Rettangolare ILLUMINATA

nome

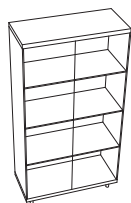

Simbolo su allegati



requisiti prestazionali

Vetrina cristalli temperati spessore 4/6 mm, anta doppia battente con serratura, 4 ripiani regolabili in altezza, illuminazione LED interna per ogni ripiano.

Dimensioni:  
Altezza da 180 a 200cm  
Profondità da 40 a 50cm  
Larghezza da 90 a 100cm

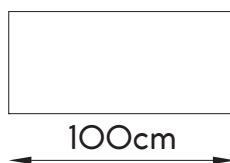
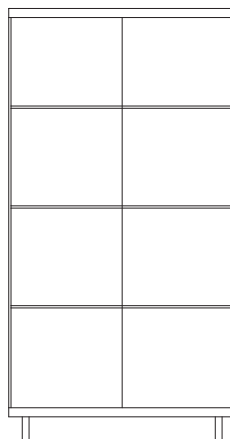

VTR502

cod.

Vetrina sez. Rettangolare.

nome



Simbolo su allegati



requisiti prestazionali

Vetrina cristalli temperati spessore 4/6 mm, anta doppia battente con serratura, 4 ripiani regolabili in altezza.

Dimensioni:  
Altezza da 180 a 200cm  
Profondità da 40 a 50cm  
Larghezza da 90 a 100cm

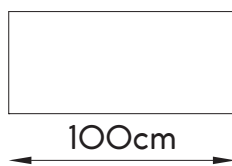
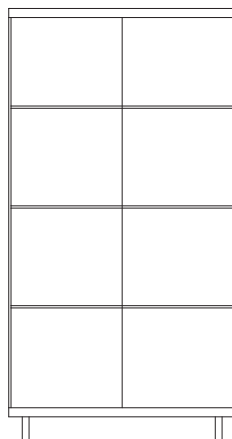



TSS551

cod.

Struttura americana sez. 30x30 o 40x40

nome

Simbolo su allegati

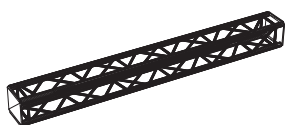

requisiti prestazionali

Truss in alluminio a sezione quadrata componibile comprensiva di minuteria.

Dimensioni:  
30x30cm.  
40x40cm.



TSS552

cod.

Elemento collegamento sez. 30x30 o 40x40

nome



Simbolo su allegati



requisiti prestazionali

Elemento di collegamento con struttura americana in alluminio.

Sezione quadrata di dimensione  
30x30cm.  
40x40cm.

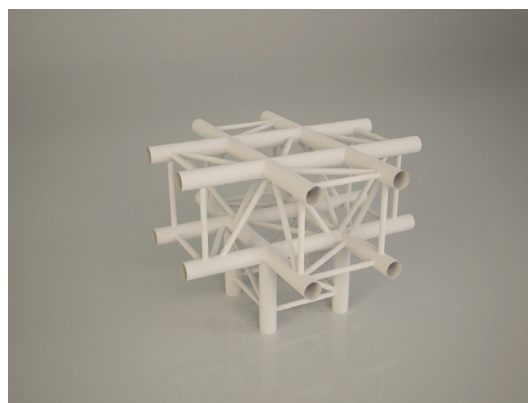
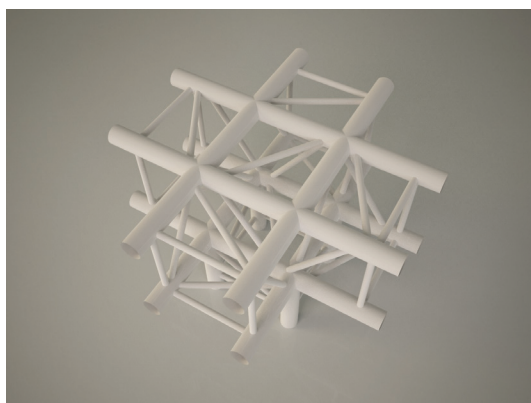

PDN601

cod.

Pedana

nome

Simbolo su allegati

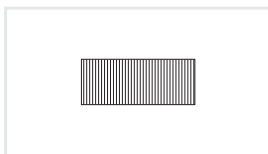
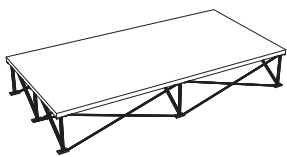

requisiti prestazionali

Pedana modulare con struttura in alluminio e ripiano in multistrato ignifugato antiscivolo profilato in alluminio.  
Altezza da terra 20cm.

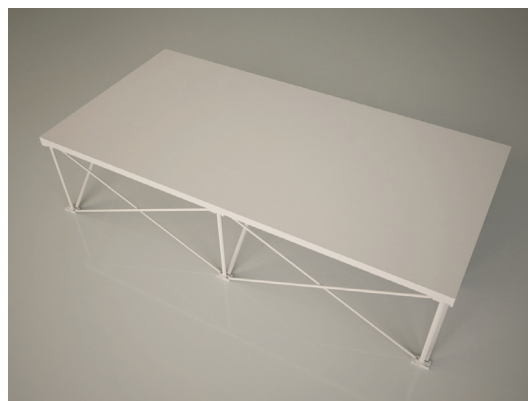
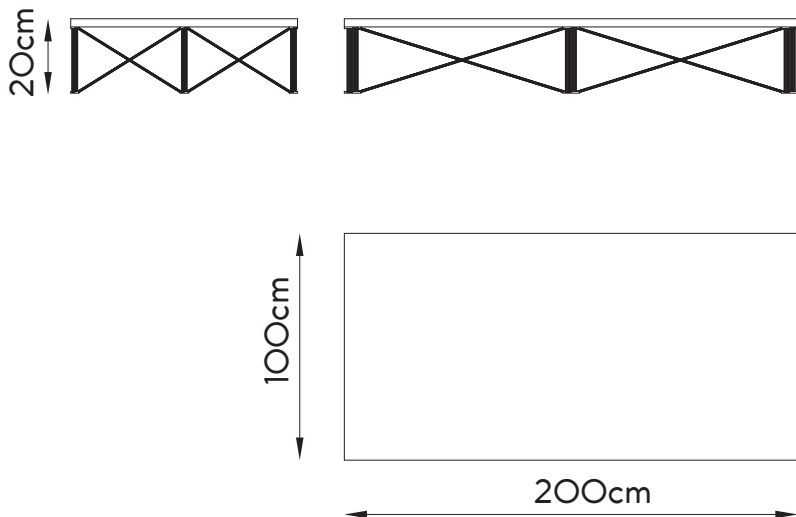

PDN6O2

cod.

Palchetto

nome

Simbolo su allegati

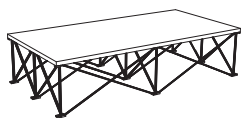

requisiti prestazionali

Palchetto modulare con struttura in alluminio e ripiano in multistrato ignifugato antiscivolo profilato in alluminio.

Altezza da terra 40cm.

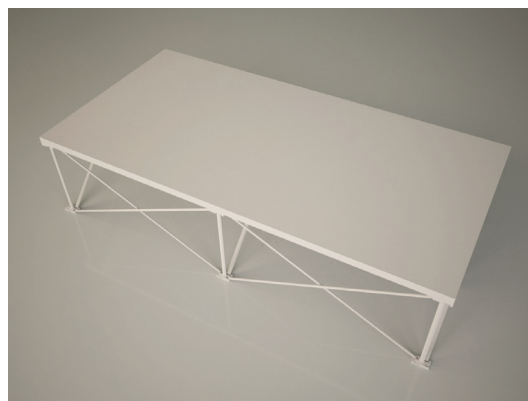
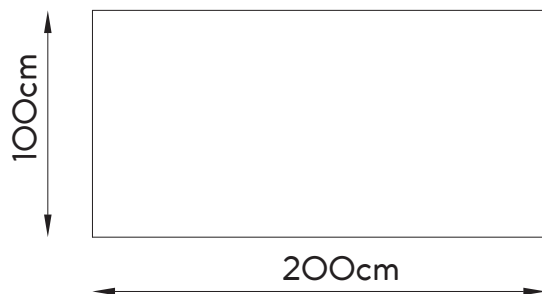
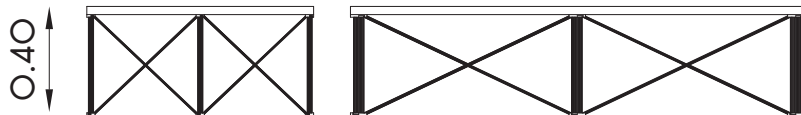

MOQ651

cod.

Moquette Classe 1

nome

Simbolo su allegati

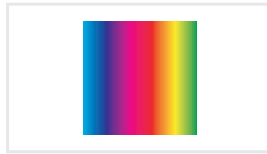

Colore su allegati in base ai progetti

requisiti prestazionali

Moquette Classe 1

Colorazioni varie su richiesta.

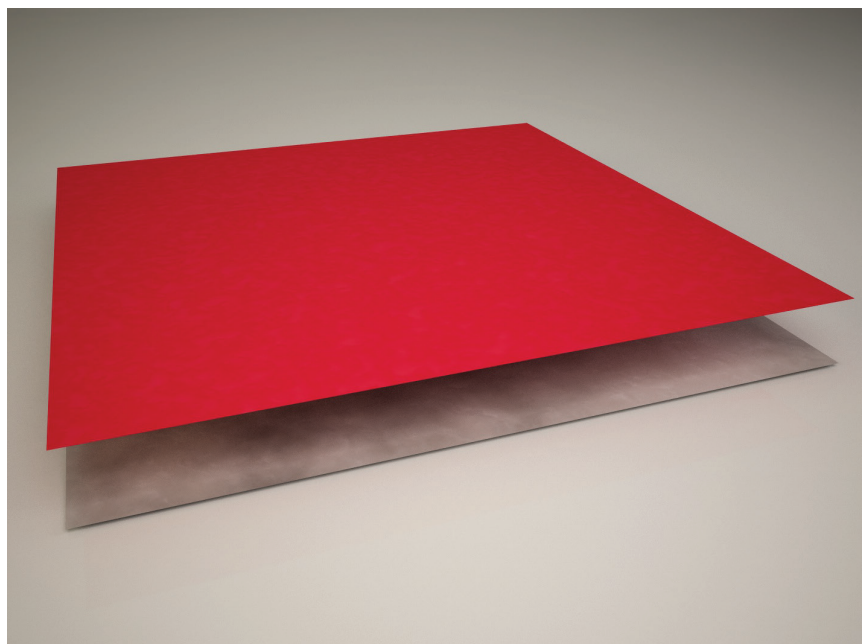

MOQ652

cod.

Pavimentazione in PVC

nome

Simbolo su allegati

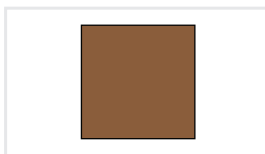

requisiti prestazionali

PVC autoposante per ambienti destinati ad attività ricreative e gastronomiche.

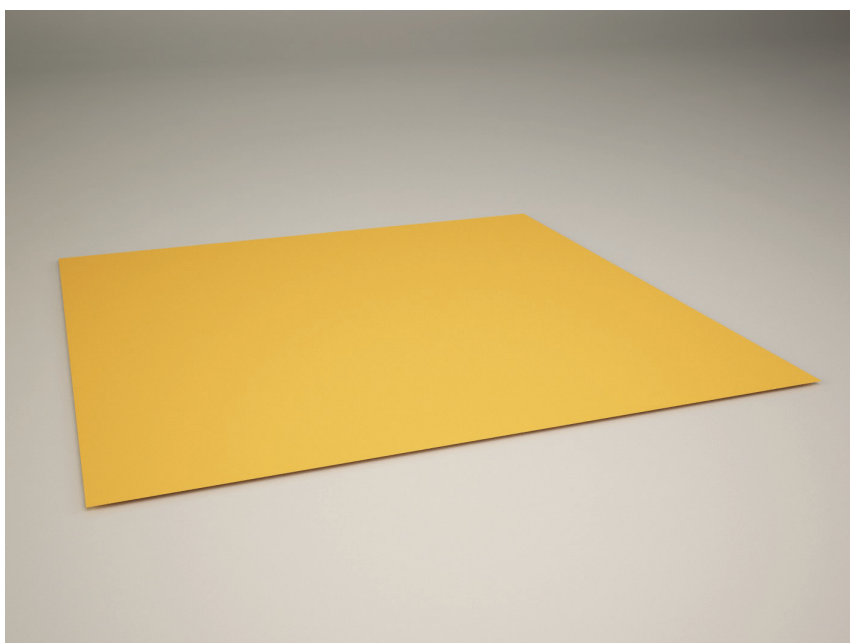

ARD701

Mobiletto due ante con chiave

cod.

nome



Simbolo su allegati

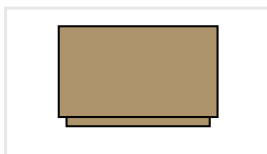

requisiti prestazionali

Mobiletto.  
Colori possibili nero/grigio/bianco/rosso.

Con almeno 2 ripiani interni.  
Serratura con chiave.

Dimensioni:  
Altezza da 110 a 130cm  
Profondità da 35 a 50cm  
Larghezza da 90 a 100cm

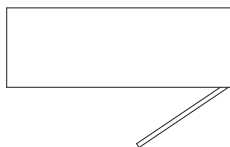
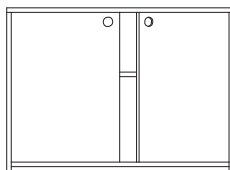
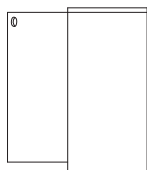

ARD7O2

cod.

Cestino

nome

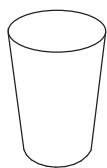

Simbolo su allegati



requisiti prestazionali

Gettacarte - Cestino in PVC.

Colore richiesto Nero/grigio/bianco/rosso.

Capacità 10l.  
Diametro 25/30cm  
Altezza 25/30cm



Left



Front



Top





ARD7O3

cod.

Appendiabito

nome



Simbolo su allegati



requisiti prestazionali

Appendiabito struttura in metallo base di metallo o base in altro materiale.

Almeno 6 ganci indipendenti.

Dimensioni minime richieste:

Diametro 25/40cm

Altezza 175/190cm



Left



Front



Top



ARD7O4

cod.

Specchio per figura intera

nome



Simbolo su allegati

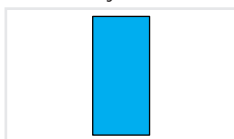

requisiti prestazionali

Specchio autoportante per figura intera.

Dimensioni:  
Altezza min 160cm

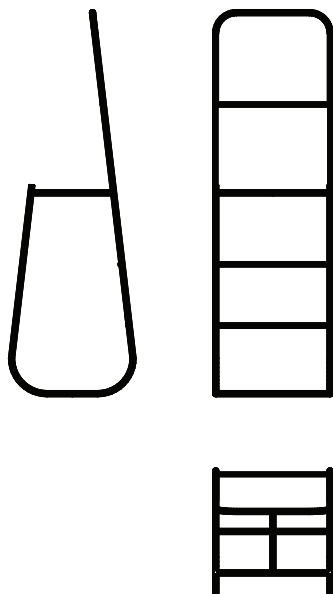

ARD706

Tendiflex

cod.

nome

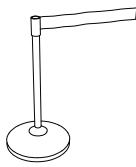

Simbolo su allegati

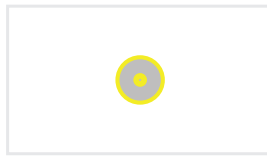

requisiti prestazionali

Colonnina tendifilo "tendiflex" con base in metallo e fusto in metallo.

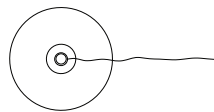
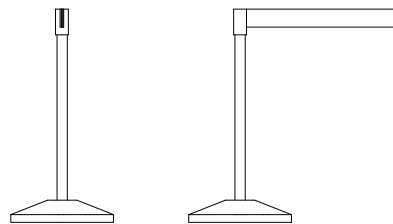

CNT751

cod.

Recinzione per interni

nome

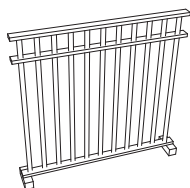

Simbolo su allegati

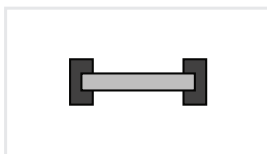

requisiti prestazionali

Recinzione interna altezza 100cm  
in metallo o PVC.

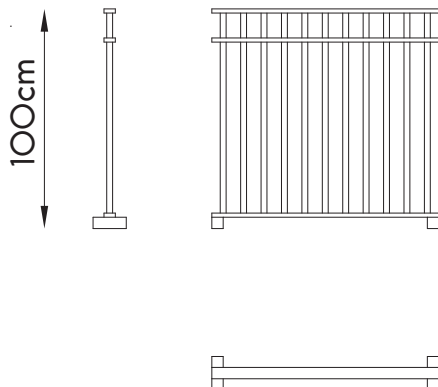

CNT752

cod.

Recinzione metallica leggera per uso esterno

nome

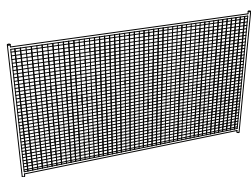

Simbolo su allegati



requisiti prestazionali

Recinzione alta a maglie strette  
leggera per delimitazione aree da  
cantiere (tipo orso-gril)  
Comprensive di basi per consentire  
il sostegno verticale.

Dimensioni  
Altezza 200cm.  
Larghezza 330cm.

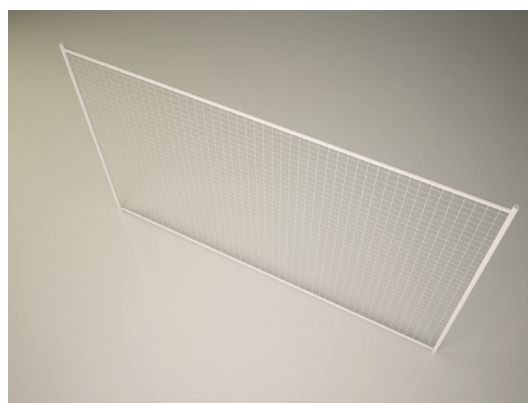
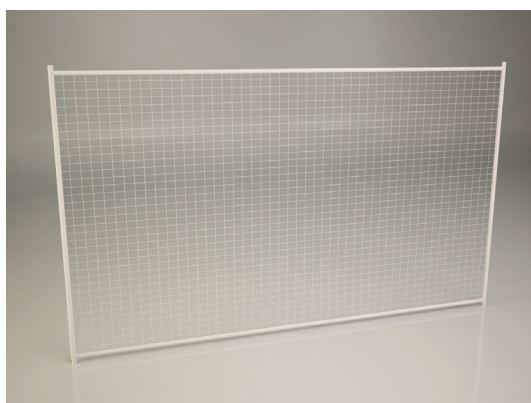

CNT753

cod.

Recinzione metallica pesante per uso esterno

nome

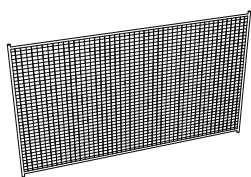

Simbolo su allegati



requisiti prestazionali

Recinzione alta pesante per delimitazioni aree concerti/eventi/cantieri.

Modulabile  
Antiribaltamento

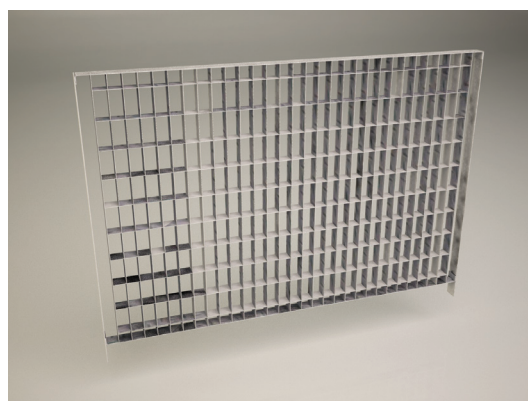
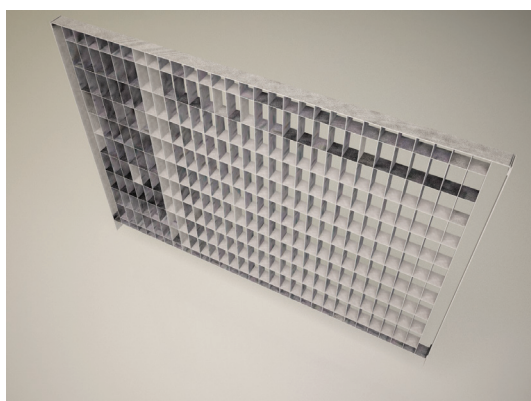

CNT755

cod.

Recinzione metallica antipanico antiribaltamento

nome

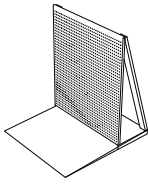

Simbolo su allegati



requisiti prestazionali

Recinzione antipanico antiribaltamento per concerti / palchi.

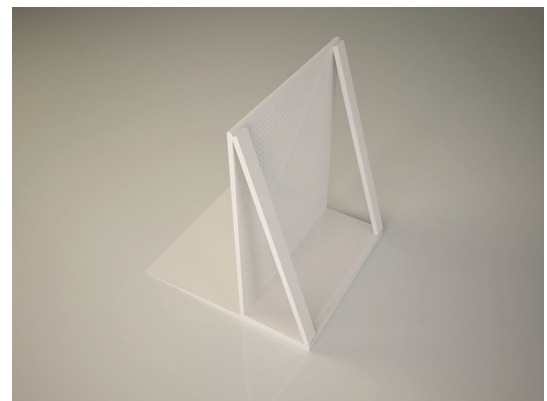
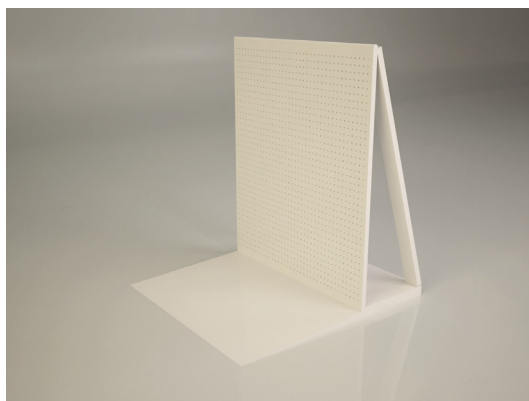
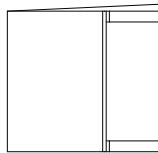
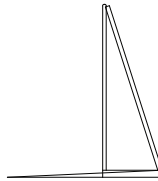
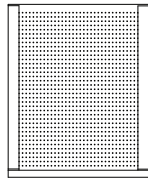

CNT756

cod.

Pavimentazione carrabile

nome

Simbolo su allegati

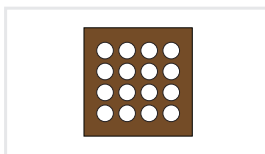

requisiti prestazionali

Pavimentazione carrabile per mezzi e persone.  
Utilizzabile in esterno





CNT757

cod.

Torre faro autoalimentata

nome

Simbolo su allegati

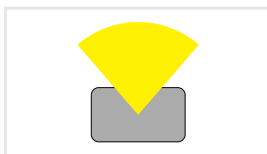

requisiti prestazionali

Torre faro autoalimentata.

